



# **HIGH-PERFORMANCE RECORDING VIDEO BORESCOPE SYSTEM with VGA RESOLUTION ARTICULATING PROBE**

*USER'S MANUAL*



## **DCS16HPART**

*Please read this manual carefully and thoroughly before using this product.*

---

# TABLE OF CONTENTS

<b>Introduction</b> .....	<b>3</b>
<b>Key Features</b> .....	<b>4</b>
<b>Safety Instructions</b> .....	<b>4</b>
<b>What's in the Case</b> .....	<b>4 – 5</b>
<b>Product Overview</b> .....	<b>5 – 6</b>
<b>Setup Instructions</b> .....	<b>7 – 8</b>
<b>Attach Probe</b> .....	<b>7</b>
<b>Charge Battery</b> .....	<b>7</b>
<b>Insert SD Card</b> .....	<b>7</b>
<b>Operating Instructions</b> .....	<b>8 – 14</b>
<b>Viewing Live Video on the Console</b> .....	<b>8</b>
<b>Operating the Probe</b> .....	<b>8 – 11</b>
<b>Using the Three Control Buttons</b> .....	<b>8 – 9</b>
<b>Attaching the Mirrored Viewing Tip (Optional)</b> ..	<b>10 – 11</b>
<b>Viewing Live Video on a TV Monitor</b> .....	<b>11</b>
<b>Taking Pictures and Recording Videos</b> .....	<b>11 – 12</b>
<b>Viewing Photos and Playing Back Videos</b> .....	<b>12</b>
<b>Accessing SD Card Content</b> .....	<b>12 – 13</b>
<b>Navigating the Main Menu</b> .....	<b>13 – 14</b>
<b>Specifications</b> .....	<b>15 – 16</b>
<b>Operating, Maintenance &amp; Troubleshooting Tips—     H16 Console</b> .....	<b>16</b>
<b>Operating &amp; Maintenance Tips—P16HPART Probe</b> .....	<b>17</b>
<b>Compatible Probes &amp; Accessories</b> .....	<b>18</b>
<b>Warranty Information</b> .....	<b>19</b>
<b>Return for Repair Policy</b> .....	<b>19</b>

---

# INTRODUCTION

Thank you for purchasing General Tools & Instruments' (General's) DCS16HPART High-Performance Recording Video Borescope System with VGA Resolution Articulating Probe. Please read this user's manual carefully and thoroughly before using the instrument.

The DCS16HPART is a complete system that combines an H16 Handheld Recording Video Borescope Console with a P16HPART VGA Resolution Articulating Probe, which is 1m (39 in.) long and has a diameter of 6mm (0.23 in.). A list of all probes compatible with the H16 console can be found on p. 18.

The H16 is a handheld computerized console with a 3.5-inch (diagonal) color LCD. A thumbwheel on the left side of the H16 allows you to adjust the brightness of the LEDs illuminating the camera at the end of an attached probe. A horizontal line of green bars indicating the brightness level temporarily appears on-screen whenever the unit is powered on or the brightness is changed.

The console has three operating modes: Preview, Playback and Menu:

- **In Preview mode**, video framed by the camera's field of view is displayed in real time on the console's LCD. The H16 automatically enters this mode when powered on. A front-panel button allows you to double the size of a target (a zoom level of 2X). The same button allows you to "mirror" video, making it possible to read serial numbers seen and "reversed" by an attached probe with a mirrored viewing tip. The zoom and mirroring functions can be applied at the same time. In Preview mode, real-time video also can be exported through an included video cable to any NTSC- or PAL-format TV monitor with an RCA input jack.

Operating in Preview mode, the H16 also allows you to record inspection videos (at 320 x 240 pixel resolution) and photos (at 640 x 480 pixel resolution) on an included SD memory card by pressing icon-labeled buttons on the console's front panel. The remaining front-panel buttons enable access to Playback and Menu modes.

- **In Playback mode**, you can browse the SD card for saved video and picture files and view the media on the console's LCD or a larger TV monitor. Video clips and photos also can be viewed on a PC in either of two ways: 1) by removing the SD card and plugging it into the computer directly or through a card reader; or 2) by using a supplied cable to connect the H16 to the PC through one of its USB ports. Because videos are saved as .avi files and photos as .jpg files, applications found on most PCs (Microsoft Windows Media Player and Microsoft Office Picture Manager) can open the files. The 4GB SD memory card included with the H16 can store at least 10 hours of video, recorded at an average of 6 Mbytes/minute, in addition to hundreds of photos.
- **In Menu mode**, you use familiar scrolling motions and responses to dialog boxes to navigate a main menu with six submenus. When selected, submenu items execute "housekeeping" functions such as deleting files, setting the date and time, enabling or disabling date and time stamps, choosing any of 27 languages for display indications and menu options, selecting a Video out format and disabling or adjusting the console's Auto Power Off trigger.

---

## KEY FEATURES

- 3.5 in. diagonal color LCD for viewing probe video in real time and saved video and pictures later
- 1m (39 in.) long soft metal articulating probe with IP67 ingress protection rating and range of  $\pm 150^\circ$  and diameter of 6mm (0.23 in.). Probe has five super-bright white LEDs (three forward-facing and two side-facing) to support capture of 640 x 480 pixel (VGA) resolution video and still images. Probe controller has light boost, anti-reflection and  $90^\circ$  image rotation buttons.
- Console is compatible with dozens of high-performance camera-tipped probes from General (see p. 18)
- Thumbwheel for adjusting brightness of camera lighting
- Familiar menu-driven user interface for viewing and recording videos and photos on standard SD memory card (4GB card included) and playing back media on console, TV or PC
- Rechargeable battery with 4-hour capacity
- 1-year limited warranty

---

## SAFETY INSTRUCTIONS

### **CAUTION!**

***Never insert a probe attached to the H16 into a structure or space known or suspected to contain live electric wiring***

- The H16 is intended for industrial applications only. Do not use it for human or any other biological inspections.
- Never insert an attached probe into any flammable gas or liquid (including fuels in an oil, gasoline or diesel tank)
- Do not disassemble the instrument. Doing so creates a potentially fatal electrical hazard (and voids the warranty as well).

---

## WHAT'S IN THE CASE

The DCS16HPART comes in a custom hard plastic protective carrying case. Inside the case are:

- The H16 console. The console integrates an LCD monitor, a connector for a high-performance camera-tipped probe from General, and front-panel controls for controlling the camera's lights, adjusting system parameters, and recording and playing back videos and photos captured by an attached probe.
- A P16HPART soft metal VGA Resolution Articulating Probe of 1m (39 in.) length and 6mm (0.23 in.) diameter
- A 4GB SD memory card
- An AC adaptor/battery charger for a 110/220VAC supply. The adapter has a 5.5VDC, center-positive output plug.
- A video cable for connecting the H16 to a TV monitor. The cable has RCA plugs at one end and a mini-stereo plug at the other end.
- A  $70^\circ$  mirrored probe viewing tip

- A USB cable with a mini-USB plug on one end and a full-size USB plug on the other end. It can be used to display the contents of the SD card on a computer directly, without removing the card from the console.
- A microfiber screen cleaning cloth
- This user’s manual

## PRODUCT OVERVIEW

Fig. 1 shows the names and locations of all of the controls, ports and jacks of the H16. Fig. 2 (on the next page) shows the controls and physical features of the P16HPART VGA Resolution Articulating Probe. Table 1 (also on the next page) details how the function of each front-panel button on the H16 changes with the console’s operating mode. Familiarize yourself with the labels, positions and functions of all buttons and connectors before moving on to the Setup Instructions and Operating Instructions.

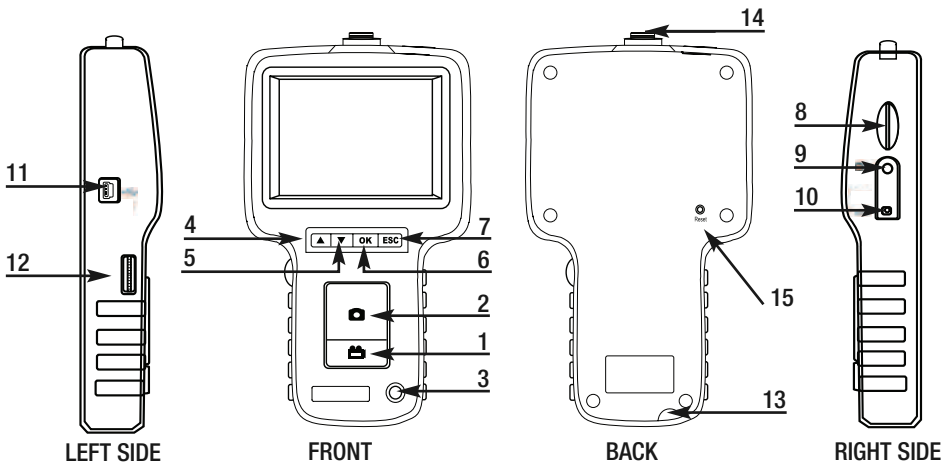
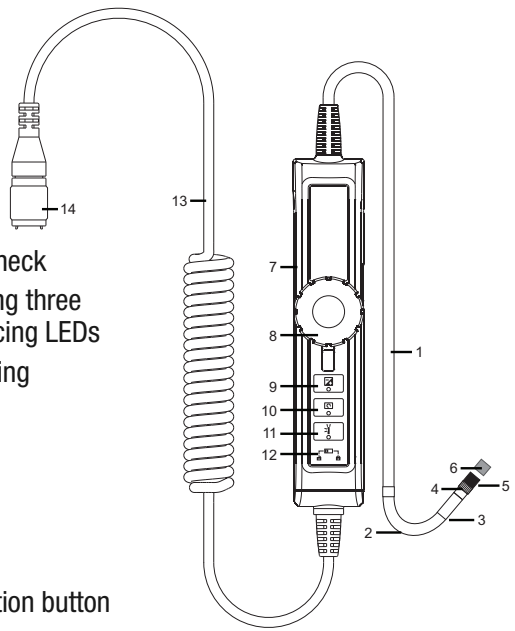

**Fig. 1. The controls, ports and jacks of the H16**



- |   |                                      |    |                                  |
|---|--------------------------------------|----|----------------------------------|
| 1 | Start/Stop Video Recording Button    | 10 | AC Adaptor Jack                  |
| 2 | Snapshot Button                      | 11 | Mini-USB Jack                    |
| 3 | Power On/Off Button                  | 12 | Brightness Adjustment Thumbwheel |
| 4 | Previous Video/Photo Button          | 13 | Hanger Hole                      |
| 5 | Next Video/Photo Button              | 14 | Probe Connector                  |
| 6 | <b>OK</b> OK Button                  | 15 | Reset Button                     |
| 7 | <b>ESC</b> Escape/Zoom/Mirror Button |    |                                  |
| 8 | SD Card Socket                       |    |                                  |
| 9 | TV Out Jack                          |    |                                  |

**Fig. 2. The controls and physical features of the P16HPART VGA Resolution Articulating Probe**

1. Probe
2. Flexible-obedient, remote-controlled neck
3. Stainless steel camera head containing three forward-facing LEDs and two side-facing LEDs
4. Stainless steel accessory alignment ring
5. Black metal thread protector ring
6. Red rubber protective cap
7. Probe controller body
8. Articulation angle control wheel with locking lever
9. Light boost button
10. 90° rotation button
11. Anti-reflection button
12. Button lock switch
13. Probe connector cable
14. Probe connector



**Table 1. The H16's multi-function buttons**

Button Label	In Preview Mode	In Playback Mode	In Menu Mode
▲	Switches to Playback mode	Selects next-oldest video or photo	Moves up one line; when setting <b>DATE/TIME</b> , moves back one field
▼	Switches to Playback mode	Selects next-newest video or photo	Moves down one line; when setting <b>DATE/TIME</b> , moves ahead one field
<b>OK</b>	Switches to Menu mode	Pauses/plays video clip	Executes highlighted command
<b>ESC</b>	<b>Pressed briefly</b> , enlarges target by 100% (zooms 2X); <b>Pressed and held</b> , mirrors video	Switches to Preview mode	Switches to Preview mode
	Takes a picture (stores .jpg photo on SD card)	N/A	When setting <b>DATE/TIME</b> , increases value by one unit per button press. Also used to enable/disable superimposition of date and time stamps on photo/video displays.
	Starts/stops recording an .avi video on SD card	Enables deletion of any individual photo or video	When setting <b>DATE/TIME</b> , decreases value by one unit per button press

---

# SETUP INSTRUCTIONS

## **ATTACH PROBE**

To attach the **P16HPART probe** (or any other compatible probe) to the H16 console, plug the probe connector (Fig. 2, Callout 14) into the connector at the top of the console (Fig. 1, Callout 14). The connectors mate in only one way, when the two dots—one on the console's connector and the other under the collar at the end of the probe—are aligned. After you have lined up the dots, push the two connectors together so the alignment keys on opposite sides of the probe's connector slide over the flats of the console's connector. Slide the collar on the probe's connector forward and tighten the collar by turning it clockwise.

You can now peel away the plastic film that protects the console's LCD.

## **CHARGE BATTERY**

To power on for the first time, plug one end of the supplied AC adaptor/battery charger into a wall socket. Then swing the black rubber protective flap away from the right side of the H16 to expose the AC adaptor jack (Fig. 1, Callout 10). Insert the cylindrical plug at the end of the adaptor/charger cable into the AC adaptor jack. This will begin charging the console's battery.

Push the **⏻** button and hold it for at least five seconds. The LCD will illuminate. It will first show a color-bar test pattern, and then (briefly) a battery icon at lower left, superimposed on video being captured in real time by the camera at the end of the probe.

Use the thumbwheel on the left side of the console (Fig. 1, Callout 12) to adjust the intensity of the camera's lighting. In a brightly lit room, moving the thumbwheel has a big effect on the brightness of the LEDs at the tip of the probe, but a much smaller effect on the brightness of video on the screen. The on-screen impact of changing brightness is more pronounced in dark environments.

To turn off the H16, push the **⏻** button and hold it for at least five seconds.

It will take several hours to fully charge the H16's Lithium-ion battery the first time. **You cannot replace the battery**, which can only be replaced by General-authorized service personnel. **Do not open the case in an attempt to change the battery yourself.** Doing so creates a potentially fatal electrical hazard (and voids the warranty as well) with the AC adapter plugged in.

With proper care (charging the battery often, and never allowing it to completely discharge), you can expect the H16's battery to last four or five years. A fully charged battery should power at least four hours of operation.

## **INSERT SD CARD**

This step enables the H16 to store video clips and photos. Remove the supplied 4GB SD memory card from its packaging. Discard the packaging, but save the plastic storage case.

Push the SD card into the socket on the right side of the console (Fig. 1, Callout 8). Be sure the card's gold contacts are facing the rear of the unit and enter the socket first. Push in the card until you feel it spring back and you hear a click.

To remove the card later, push it in gently until you hear a click and the card pops out far enough for your fingers to grab.

# OPERATING INSTRUCTIONS

## VIEWING LIVE VIDEO ON THE CONSOLE

While the battery charges, General recommends becoming familiar with the H16's controls, indicators and menu options in Preview mode, before taking the unit out into the field. The H16 operates the same way whether powered by its battery or the AC adapter.

To begin, power off the unit by pressing and holding the  button. Then press and hold the button again to power the console back on. Each time the console is powered on, the screen shown below right will appear briefly. The battery icon at left will be in white and the bars at right will be in green, superimposed on live video captured by the camera probe. Together, the number of bars and the color of the icon represent the H16's two "vital signs"—available memory capacity and battery charge, respectively.

The number of filled-in bars at the right of the screen reflects the amount of data currently stored on the SD card. A full card would produce four bars. The whiter the  icon at lower left, the higher the current level of battery charge. A completely white icon indicates a fully charged battery.

Next, practice manipulating the articulating probe. Typically, borescope users insert their probe into an orifice (a hole in a wall or an engine's cylinder, for example) or into an inaccessible or hazardous area (the back or an equipment rack or an engine compartment, for example) to view components or environments that would otherwise be invisible. Compared to an obedient probe, your soft metal articulating probe is more flexible, but it does not retain its shape. Its obvious advantage is articulation. Using the articulation angle control wheel (Fig. 2, Callout 8), you can turn the probe tip to inspect targets off the main axis of the probe while it is in a tight space, without having to remove and re-insert the probe.

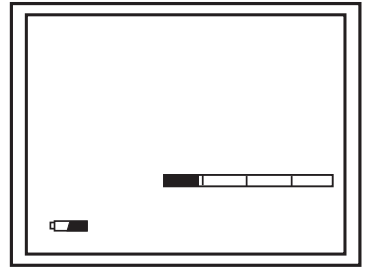

## OPERATING THE PROBE

Before attempting to articulate the probe, make sure that the lever below the articulation angle control wheel is pointing downward. **To bend the probe neck** (Fig. 2, Callout 2) **and tip** to the left, turn the wheel clockwise. To bend the probe neck and tip to the right, turn the wheel counterclockwise. **To lock the wheel and the probe's articulation angle**, move the lever below the wheel to the left (see figure at right).

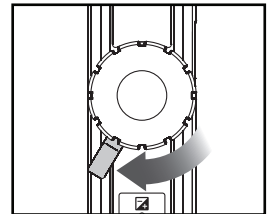

Remember to remove the red rubber protective cap from the tip of the probe before using it.

## Using the Three Control Buttons

**To boost the intensity of the three LEDs** that normally provide camera lighting, press the  button. Doing so lights a red LED behind the button and improves the brightness of video and images, as shown at the top of the next page.



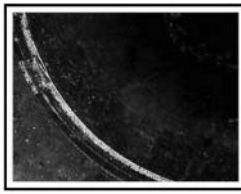

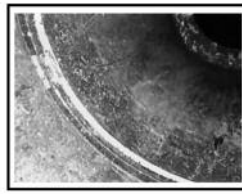

BEFORE BOOST



AFTER BOOST

This feature can help you cope with very low-light conditions. When recording with the boost feature activated, you must hold the probe very steady or your videos and images will be blurred.

**To rotate the probe's field of view**, use the  button. Pressing the button once backlights the button red and rotates the frame clockwise by 90°. Pressing it a second time rotates the frame by an additional 90°, in effect turning the original view upside-down. Pressing the  button a third time rotates the field of view yet another 90°. Pressing the button a fourth time restores the original view and extinguishes the red button backlight.

To remove glare, reflections or spots from the field of view, use the  button. Pressing the button adds a red backlight to it, just like the other two buttons on the VGA Resolution Articulating Probe controller.

This anti-reflection feature of the P16HPART is most useful for eliminating reflections of the three forward-facing LEDs in the camera head from shiny surfaces. Note that pushing the  button extinguishes the three forward-facing LEDs and shifts responsibility for camera lighting to the two side-facing LEDs. The net effect, as shown below, is a clearer and more-readable image.



WITHOUT ANTI-REFLECTION



WITH ANTI-REFLECTION

You can also use the anti-reflection function to remove glare created by the P16HPART's mirrored viewing tip (see the next section of this manual for installation and alignment instructions). The pair of images below illustrates the net positive effect.

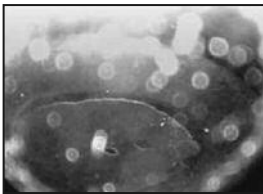

MIRRORED VIEW  
WITHOUT ANTI-REFLECTION

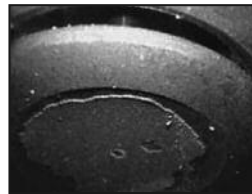

MIRRORED VIEW  
WITH ANTI-REFLECTION

## Attaching the Mirrored Viewing Tip (Optional)

The P16HPART includes a 70° mirrored viewing tip. To attach the tip to the probe:

1. Pull off the red rubber protective cap (Fig. 2, Callout 6).
2. Unscrew and remove the black metal thread protector ring (Callout 5), as shown at right.
3. Turn the stainless steel accessory alignment ring (Callout 4) clockwise to move it away from the probe tip. Keep turning until the ring can travel no further.
4. Screw the mirrored viewing tip onto the camera head (Callout 3) by turning it clockwise, as shown at right. Keep turning until the viewing tip is as far from the probe tip as possible. In this position, it can rotate freely.
5. Press the  button to activate the two-side facing LEDs.
6. Slowly turn the mirrored viewing tip counterclockwise to move it toward the probe tip. Once the threads of the tip grip the camera head, continue turning only until the two LEDs are clearly visible through the gap in the tip's housing.
7. Secure the tip with the thumb and forefinger of one hand and use your other hand to turn the alignment ring clockwise. Keep turning the ring until its leading edge contacts the mirrored viewing tip, locking it in place. The pair of figures at right illustrate the incorrect (left) and correct (right) orientation of the mirror with respect to the LEDs.

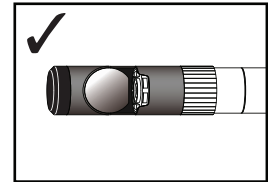
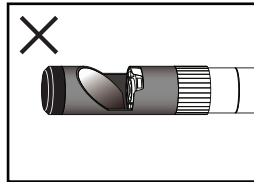
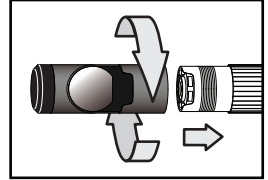
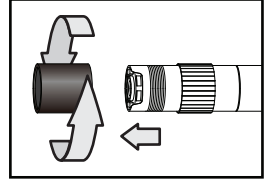

Remove the blue circular protective film from the mirror by pulling on its tab with a tweezers.

In many cases—inspecting the interior of an engine cylinder, for example (see photo at right)—adequate clearance will not be an issue for the P16HPART probe. In fact, the  $\pm 150^\circ$  articulation range enables “look back” inspections of intake and exhaust valves from within the cylinder.

Now that you have gained some experience operating the probe with the console, note the dual function of the console's **ESC** button in Preview mode:

- **Press the ESC button briefly** and targets will be doubled in size (a zoom level of 2X). The text **+2.0x** will appear at the lower right of the LCD.
- **Press and hold the ESC button** and video will be mirrored horizontally, as shown in the two photos at the top of the next page. The effect makes it possible to read text or serial numbers “reversed” by an attached probe with a mirrored viewing tip—by undoing the reversal. An icon of a mirror will appear at the lower right of the LCD to indicate that video is being mirrored.

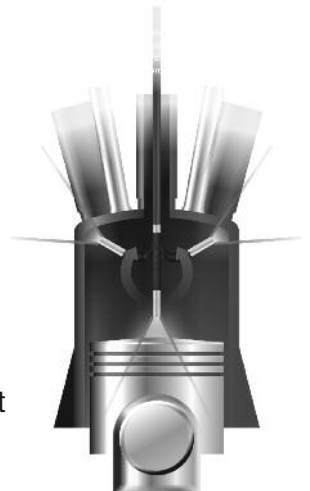



You can mirror and zoom videos at the same time by pressing the **ESC** button briefly, and then pressing and holding the button.

### **VIEWING LIVE VIDEO ON A TV MONITOR**

The system comes with a video cable for connecting the console to a TV or TV monitor that uses either the NTSC or PAL analog broadcast standard. By making the connection, you can view live video (or saved videos and pictures) on a screen larger than the H16's.



To implement the connection in hardware, insert the stereo mini-plug of the provided cable into the TV Out jack of the H16 (Fig. 1, Callout 9). Then insert the yellow RCA plug at the other end of the cable into the Video in jack of your TV or TV monitor. Be sure to set the TV input to external video.

Real-time videos shown on an external monitor can be zoomed or mirrored by briefly pressing or pressing and holding the **ESC** button, just as they can when viewed on the H16's LCD.

To activate the connection in software and begin exporting probe video to a TV, refer to the instructions for the **TV SYSTEM** and **AV OUTPUT** lines in the "Navigating the Main Menu" section of this manual, beginning on p. 12.

### **TAKING PICTURES AND RECORDING VIDEOS**

**To take a picture**, make sure the H16 is in Preview mode (with live video appearing on the LCD) and press the  button. Doing so creates a .jpg file of the frame being displayed at that moment and stores it on the SD card. The assigned file name (**PICT0001**, for example), briefly appears in orange at the bottom of the screen to confirm that a picture was taken. The H16 automatically returns to Preview mode after taking a picture.

**To record a video**, make sure the H16 is in Preview mode and press the  button. Doing so begins creating an .avi video file (with MPEG-4 compression) for storage on the SD card. A red dot and a red running clock appear at the lower left of the screen to confirm that a recording is in progress, and they remain there for the duration of the video. To stop recording, press the  button again. This returns the H16 to Preview mode.

While a video is being recorded, all console buttons other than the  and **ESC** buttons are disabled. Pressing the **ESC** button briefly activates the zoom function; pressing and holding it activates the mirror function. The zoom and mirror effects are both shown on the LCD and included in the recording of video clips.

The H16 will be unable to store videos and pictures if its SD memory card is full, write-protected or damaged. When the instrument senses any of these conditions, it will superimpose the word **FULL** on the screen in Preview mode. To remedy the situation,

either replace the full SD card by another card with spare capacity, or delete files individually or in bulk. Instructions for deleting files can be found later in this user's manual.

## **VIEWING PHOTOS AND PLAYING BACK VIDEOS**

**To view a picture** or play back a video (or more than one picture or video) on the H16's LCD or a TV monitor, switch the unit out of Preview mode and into Playback mode by pressing the ▲ or ▼ button. In Playback mode, pressing the ▼ button repeatedly recalls all photos and videos from memory in the reverse order in which they were created and stored (in other words, the newest first and the oldest last). Each press of the ▲ button selects the next oldest picture or video. When a video clip is next in line (cued up), an icon of a film strip and the duration of the clip appear at the upper left of the display. As each picture is displayed and each video is cued up, its file name is shown at the bottom of the screen and its position in the storage queue is shown at upper right. For example, the 10th file of the 35 currently stored on the SD card would be indicated by 10/35.

To play a video that has been cued up, press the **OK** button. A ► icon and a running clock will appear on-screen below the playing video. To pause the video, press the **OK** button. This replaces ► by ⏸. To resume playing the video clip, press the **OK** button again.

While each photo and video is on-screen, pressing the  button gives you the option to delete its file. Pressing the button superimposes the word **DELETE** at the lower left of the screen and [**OK**] at the lower right. Press **OK** to delete the file.

Whenever **DELETE** and [**OK**] are shown on-screen, you can use the ▲ and ▼ buttons to navigate to other individual stored files for the purpose of deleting them. To exit the **DELETE** screen, press the **ESC** button.

## **ACCESSING SD CARD CONTENT**

Photos and videos stored on the SD card also can be viewed on a PC. If your computer has an SD card slot, you can remove the card from the H16 and plug it directly into a PC. If your PC does not have an SD card slot, you can purchase a USB SD card reader (Part No. SDRD1) from General.

If you choose to remove the SD card from the console and plug it into a PC, either directly or through a card reader, remember to eject the card from the PC once you are done viewing (and/or copying) the files it contains. Depending on your PC's startup settings, your computer may fail to restart following its next shutdown if the SD card remains inserted. The PC's operating system may try to reboot from the SD card and be unable to do so.

Another option for viewing inspection video and photos on a PC is to use the supplied USB cable to link to the computer. The first time you connect the H16 to a computer in this way, the H16 screen will go dark (except for the white text **MASS-STORAGE MODE**) and you will be prompted that "Driver Software is Being Installed." The final Driver Software Installation dialog box advises that "Your device is ready to use." Your PC's AutoPlay function will then produce a screen pop to notify you that a removable disk has been connected. Double-clicking "Open folder to view files" reveals the contents of that disk to be a folder named "DCIM". Double-clicking the DCIM folder icon reveals a subfolder named "100MEDIA" that contains all the videos and pictures you have saved on the SD card.

While the USB cable is attached, however, you cannot view real-time videos on the H16's LCD, a TV monitor, or your computer. You cannot even record videos or take photos and store them on the SD card. Disconnecting the cable returns the H16 to Preview mode. The only benefit of using the USB cable is that you do not have to remove the SD card to view its content on a PC.

## NAVIGATING THE MAIN MENU

The main menu of the H16 provides access to the following housekeeping and operational functions:

- Bulk and individual file erasure
- Video exporting
- Setting the date and time
- Choosing a display language
- Selecting a TV format
- Enabling/disabling and adjusting the Auto Power Off function

Menu mode has a hierarchical structure and uses prompts and dialog boxes familiar to anyone who has used an Automated Teller Machine (ATM). The only constraint on using the menu is your own response speed. **If no selection is made within 2-1/2 minutes following Menu mode startup, the console will automatically revert to Preview mode.** The same time constraint applies to selections within submenus. **If you do not respond to a prompt (indicated by a flashing word or line of text) within 2-1/2 minutes, the H16 will switch back to Preview mode**—its default operating state.

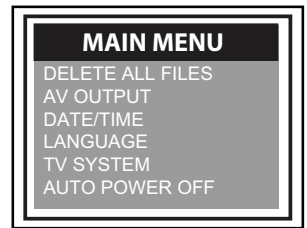

To access the main menu, press the **OK** button to enter Menu mode. Doing so brings up the screen shown above right.

To navigate the main menu, use the **▲** and **▼** buttons to move up and down until the parameter you wish to change is highlighted in red. Then push the **OK** button to select it and call up its submenu.

The **DELETE ALL FILES** line gives you two options (yes and no) that can be selected using the **▲** and **▼** buttons. The sequence is similar to the previously described procedure for deleting an individual photo or video.

The **AV OUTPUT** line allows you to send the real-time video stream shown on the display unit out through the unit's TV out jack to an NTSC or PAL TV monitor. The H16's display will turn black until you select this option again. Before activating this function, make the physical connection described in the "Viewing Live Video on a TV Monitor" section. If you have forgotten to make the connection, you will be prompted "**NO AVOUT CABLE**" when you attempt to activate this function.

The **DATE/TIME** line allows you to set the H16's calendar and clock. Doing so is necessary only if you wish to keep track of your photo and video files by date and time.

When **DATE/TIME** is selected, the first screen that appears shows the year in red. To decrease the value by one, press the **⏪** button. To increase the value by one, press the **⏩** button. Once you have set the year, advance to the next field—the month—by pressing the **▼** button. Set the month as you did the year, by using the **▲** and **▼**

buttons to increase or decrease the value by one unit per button press. Repeat this process until all six date and time fields have been set. Then push the **OK** button to save the settings. To back up from any field to the previous field, press the **▲** button.

The lower line of the **DATE/TIME** screen allows you to choose whether or not to superimpose the date and time on the display in Preview mode. To always superimpose the date and time, navigate down to the lower line until the word **YES** to the right of the word **DISPLAY** is shown in red. Press the **OK** button to save the setting. To NOT superimpose the date and time, when **YES** is shown in red press the **▶** button to change **YES** to **NO**. Then press the **OK** button to save the setting.

The **LANGUAGE** line of the main menu allows you to view the main menu, as well as the **DELETE** screens for individual photos and videos, in any of 27 languages (see the Specifications section on pp. 14–15 for a complete list). Use the **▲** and **▼** buttons to navigate to the language you wish to use and then push the **OK** button.

The **TV SYSTEM** line enables you to choose either **NTSC** or **PAL** formatting of the videos you export to a TV monitor. Press either the **▲** and **▼** button to make your choice and then push the **OK** button to save the setting.

The **AUTO POWER OFF** of the main menu is not visible on the screen that first appears after you press the **OK** button to put the H16 into Menu mode. To show the line, scroll down past the **VIDEO FORMAT** line. When the **AUTO POWER OFF** line appears, press the **OK** button.

By default, the **AUTO POWER OFF** function of the H16 is disabled. To enable it, and to choose how quickly to power off the instrument following a period of inactivity, navigate to one of the four options (5, 10, 15 or 30 minutes) and press the **OK** button when the duration you prefer is highlighted in red. To re-disable the function later, enter Menu mode, scroll down to the **AUTO POWER OFF** line, press the **OK** button, select **OFF** and press the **OK** button again to save the setting.

---

# SPECIFICATIONS

## H16 CONSOLE

Display Type	Color TFT LCD
Display Size	3.5 in (89mm) diagonal
Display Resolution	320 by 240 pixels (QVGA)
Video Recording Resolution	320 x 240 pixels (QVGA)
Video File Format	.avi
Photo Recording Resolution	640 x 480 pixels (VGA)
Photo File Format	.jpg
Video Out Formats	NTSC, PAL
Video Frame Rate	30 fps
Compression Format	Compatible with MPEG4
Signal-to-Noise Ratio	42dB or greater
Recording Medium	Standard-size SD card
Interfaces	AV out, USB 2.0
Languages	English, French, German, Italian, Spanish, Portuguese, Japanese, Traditional Chinese, Simplified Chinese, Danish, Dutch, Polish, Russian, Bulgarian, Turkish, Swedish, Finnish, Norwegian, Estonian, Lithuanian, Latvian, Hungarian, Czech, Slovak, Slovenian, Romanian, Greek
Power Source	Rechargeable 3.7V Li-ion battery
Power Consumption	1.8A @ 5.5VDC
Operating Temperature	-4° to 140°F (-20° to 60°C)
Storage Temperature	-4° to 140°F (-20° to 60°C)
Recharge Temperature	32° to 104°F (0° to 40°C)
Console Dimensions	8.5 x 4.7x 1.4 in. (215 x 120 x 36mm)
Console Weight	13.4 oz (380g)

---

---

## SPECIFICATIONS

### P16HPART VGA RESOLUTION ARTICULATING PROBE

---

Probe Length, Type	39 in. (1m), Soft metal
Articulation Angle	$\pm 155^\circ$
Camera Head Diameter, Type	0.23 in. (6mm), Stainless steel
Camera Head Diameter with Thread Protector	0.26 in. (6.5mm)
Camera Head Length	0.9 in. (23mm)
Camera Resolution	VGA (640 x 480 pixels)
Camera Depth of Field	0.4 to 12 in. (10 to 300mm)
Camera Field of View	$87^\circ$ (diagonal)
Camera Lighting	3 forward-facing LEDs + 2 side-facing LEDs
Operating Temperature	$-4^\circ$ to $140^\circ\text{F}$ ( $-20^\circ$ to $60^\circ\text{C}$ )
Dimensions of Probe Controller	5.47 x 1.38 x 1.26 in. (139 x 35 x 32mm)
Weight of Controller	7.76 oz. (220g)

---

## OPERATING, MAINTENANCE & TROUBLESHOOTING TIPS—H16 CONSOLE

- Never remove the SD card while taking a picture or recording a video. Doing so may damage the card and erase or corrupt the photo or video.
- If the LCD suddenly goes dark, the first two things to check are the integrity of the console's connection to the probe and the charge of the console's battery. The reason for the failure also could be that you have forgotten to remove the red rubber cap that protects the tip of non-articulating probes.
- If live video begins to look spotty, streaky or intermittent, the likely reason is an under-charged battery. Plug in the AC adapter/battery charger immediately.
- Video recording requires an SD card with a fast writing speed. For maximum video quality, General recommends SD cards with a writing speed of 80X or higher.
- If the console "freezes" (pushing buttons has no effect) like a computer, straighten out a paper clip and use one end to press the Reset button on the back of the console (Fig. 1, Callout 15).
- Avoid using corrosive liquids such as alcohol to clean either the LCD or the probe. To clean the camera lens and LEDs, use a cotton swab and a small amount of cleaning solution. To clean the LCD, use the provided cloth, cotton swabs and liquid. To clean the housing of the console, use a soft, dry cloth.
- Operate and store the H16 only in a cool (under  $140^\circ\text{F}$  or  $60^\circ\text{C}$ ), dry, well-ventilated place. Avoid exposing the unit to sunlight for long periods of time.
- To avoid damaging the console, use only compatible probes and accessories.



## OPERATING & MAINTENANCE TIPS— P16HPART PROBE

The probe is flexible to make it easy for you to inspect hard-to-reach areas. Never insert or bend it by force, and never over-bend any part of the probe. Specifically:

- Do not bend the last 1 to 2 inches (25 to 50mm) of the probe by more than  $70^{\circ}$
- Do not bend the probe at any other point by more than  $90^{\circ}$
- The probe's neck is a particularly sensitive area. Never apply heavy weights or forces to the neck. Never try to bend the neck by hand; use only the control wheel. Before storing the probe, straighten the neck.

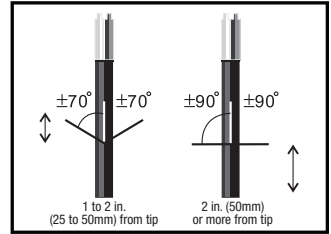

To avoid permanently damaging the delicate wires and fiber optic cables inside the probe, never curl it into a circle with a diameter of less than 6 in. (150mm).

Never use the probe or camera head to modify surroundings or to clear pathways or clogged areas.

DO NOT try to rotate the articulation angle control wheel beyond its limits.

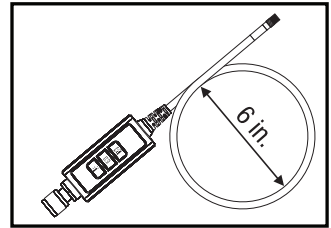

The camera head, LEDs and thread protector ring are waterproof, but not acid-proof or fire-proof. Do not touch acidic, corrosive or hot materials or they will ruin the head.

Cover the camera-tipped end of the probe with the protective red rubber cap when not using it. Remember to remove the cap from the tip of the probe before using it again.

Unless you wish to install the  $70^{\circ}$  mirrored viewing tip, do not remove the thread protector ring (Fig. 1, Callout 5). Never use the probe without attaching either an accessory or the thread protector ring to it.

Never use the probe as a hammer or hook.

When inspecting a vehicle, shut off the engine. Metal and liquid under the hood may be hot. Do not get hot oil or gas on the camera head.

If condensation forms inside the camera lens, let it evaporate before using the probe again.

Because the VGA Resolution Probe has three extra-bright LEDs that require more power than the LEDs of General's QVGA (320 x 240 pixel) resolution probes, using the P16HPART will drain the H16's battery more quickly. You will have to recharge your borescope more often.

Do not try to disassemble any part of the probe. Doing so creates an electrical hazard, could damage the probe, and voids the limited warranty.

Do not use any corrosive liquid—such as alcohol—to clean the probe body or camera head. Use a cotton swab and a mild fluid detergent to clean the body and head.

# COMPATIBLE PROBES & ACCESSORIES

The table below lists and describes all probes and accessories compatible with the H16 console

Model No. (SKU)	Description	Camera Head Diameter	Probe Length	Depth of Field
P16HPART	VGA Resolution Articulating Probe (P16HPART included with DCS16HPART system)	6mm (0.23 in.)	1m (3.28 ft.)	0.25 to 12 in. (6.4 to 300mm)
P16HP2ART			2m (6.6 ft.)	
P16HP3ART			3m (9.8 ft.)	
P16181SR-M	Flexible-Obedient Probe		1m (3.3 ft.)	
P16182SR-M			2m (6.6 ft.)	
P16183SR-M			3m (9.8 ft.)	
P16181SM-M	Soft Metal Probe	5.5mm (0.22 in.)	1m (3.28 ft.)	
P16183SM-M			3m (9.8 ft.)	
P16185SM-M			5m (16 ft.)	
P161810SM-M			10m (32 ft.)	
P161830SM-M			30m (98 ft.)	
P1839-M	Ultra-Slim Flexible-Obedient Probe	3.9mm (0.15 in.)	0.75m (2.5 ft.)	
P16182-39			2m (6.6 ft.)	
P16183-39			3m (9.8 ft.)	
P1618FS-49	Switchable Front/Side View Flexible-Obedient Probe	4.9mm (0.19 in.)	1m (3.3 ft.)	
P16182-49			2m (6.6 ft.)	
P16183-49			3m (9.8 ft.)	
P16181HP	VGA Resolution Probe	5.5mm (0.22 in.)	1m (3.3 ft.)	
P16182HP			2m (6.6 ft.)	
P16183HP			3m (9.8 ft.)	
P16PIP	Pipe & Duct Inspection Probe & Reel Set		22m (72 ft.)	0.4 in. (10mm) to infinity
RP1618	Reel Stand for Long Soft Metal Probes	_____	_____	_____

---

## **WARRANTY INFORMATION**

General Tools & Instruments' (General's) DCS16HPART High-Performance Recording Video Borescope System with VGA Resolution Articulating Probe is warranted to the original purchaser to be free from defects in material and workmanship for a period of one year. Subject to certain restrictions, General will repair or replace this instrument if, after examination, the company determines it to be defective in material or workmanship. The warranty period begins on the date of purchase. You are encouraged to register your product online. General will extend your warranty an additional 60 days if you register at [www.generaltools.com/ProductRegistry](http://www.generaltools.com/ProductRegistry).

This warranty does not apply to damages that General determines to be from an attempted repair by non-authorized personnel or misuse, alterations, normal wear and tear, or accidental damage. The defective unit must be returned to General Tools & Instruments or to a General-authorized service center, freight prepaid and insured.

Acceptance of the exclusive repair and replacement remedies described herein is a condition of the contract for purchase of this product. In no event shall General be liable for any incidental, special, consequential or punitive damages, or for any cost, attorneys' fees, expenses, or losses alleged to be a consequence of damage due to failure of, or defect in any product including, but not limited to, any claims for loss of profits.

Register now at [www.generaltools.com/ProductRegistry](http://www.generaltools.com/ProductRegistry) to receive a 60-day extension to your warranty.

---

## **RETURN FOR REPAIR POLICY**

Every effort has been made to provide you with a reliable product of superior quality. However, in the event your instrument requires repair, please contact our Customer Service to obtain an RGA (Return Goods Authorization) number before forwarding the unit via prepaid freight to the attention of our Service Center at this address:

General Tools & Instruments  
80 White Street  
New York, NY 10013  
212-431-6100

Remember to include a copy of your proof of purchase, your return address, and your phone number and/or e-mail address.



# **Specialty Tools & Instruments**

---

## **GENERAL TOOLS & INSTRUMENTS**

80 White Street

New York, NY 10013-3567

PHONE (212) 431-6100 FAX (212) 431-6499

TOLL FREE (800) 697-8665

e-mail: [sales@generaltools.com](mailto:sales@generaltools.com)

[www.generaltools.com](http://www.generaltools.com)

DCS16HPART User's Manual

Specifications subject to change without notice

©2014 GENERAL TOOLS & INSTRUMENTS

NOTICE - WE ARE NOT RESPONSIBLE FOR TYPOGRAPHICAL ERRORS.

MAN# DCS16HPART

10/09/14



General Tools & Instruments



GeneralToolsNYC