

Instruction Manual

CE

221-01 DEC. 1999

MINI CLAMP METER

CONTENTS

<i>TITLE</i>	<i>PAGE</i>
I. Safety Information	1
Environmental Conditions.....	1
Explanation of Symbols.....	1
II. Specification	2
General Specification.....	2
Electrical Specification.....	2
III. Instrument Familiarization	3
Symbol Definition.....	3
IV. Measuring Instruction	5
4.1 ACA measurement.....	5
4.2 ACV measurement.....	6
4.3 Resistance measurement.....	7
4.4 Continuity Test.....	6
V. Battery Changing	9
VI. Maintenance	9

I. Safety Information

Do not operate the tester if the body of meter or the test lead look broken.

Check the main function dial and make sure it is at the correct position before each measurement.

Do not perform resistance and continuity test on a live power system.

Do not apply voltage between the test terminals and test terminal to ground that exceed the maximum limit refer in this manual.

Exercise extreme caution when measuring live system with voltage greater than 60V DC or 30V AC.

Keep the fingers after the protection ring when measuring through the test lead.

Change the battery when the  symbol appears to avoid incorrect data.

Environmental Conditions:



Altitude up to 2000 meters.

Operating temperature: 0°C ~ 40°C, <80% RH, non-condensing

Storage temperature: -10°C ~ 60°C, <70% RH, battery removed

Pollution Degree: 2

Explanation of Symbols:

-  Attention! Refer to operation Instructions.
-  Dangerous voltage may be present at terminals.
-  This instrument has double insulation.

Approvals:  EN61010 600V CAT II 300V CAT III

II. Specification

General Specification:

Digital Display:

3 1/2 digits LCD display with maximum reading 1999

Over Load:

When the indication is larger than the 1999 counts, the LCD will show 1000 with blinking 1

Sample Rate:

2 times/sec

Low Power Indication:

When the battery is under the proper operation range,  symbol will appear on the LCD display.

Power Source: UM-4 or AAA 1.5V battery x 2.

Clamp opening size: 25mm

Dimension (L x W x H) :

187x50x29mm, 7.36x1.97x1.14 inch

Weight: 210g(include battery)

Accessory:

Instruction Manual, Carrying Case, Test lead, Battery 1.5Vx2

Battery Life: 1000 hr approx. (alkaline battery)

Electrical Specification:

The accuracy specification is defined as $\pm (\dots\% \text{reading} + \dots \text{count})$

At $23 \pm 5^\circ\text{C}$, $\leq 80\% \text{RH}$

ACA (Autorange)

Range	Resolution	Accuracy (50Hz~60Hz)	Overload Protection
200A	0.1A	2%+5	660Arms
600A	1A		

ACV (Autorange)

Range	Resolution	Accuracy (50Hz~500Hz)	Overload Protection
200V	0.1V	1.5%+5	660Vrms
600V	1V		

Ohm (Ω)

Range	Resolution	Accuracy	MAX Test Voltage	Overload Protection
200 Ω	0.1 Ω	1.9%+3	1.6Vdc	500Vrms

Continuity ($\cdot\cdot\cdot$)

Range	Active Region	MAX Test Voltage	Overload Protection
$\cdot\cdot\cdot$	<100 Ohm	1.6Vdc	500Vrms

III. Instrument Familiarization:

Symbol Definition:

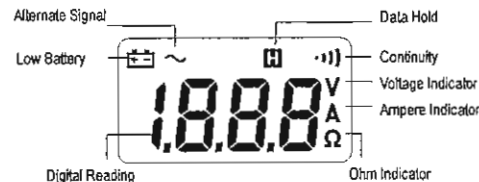

Instrument Familiarization:

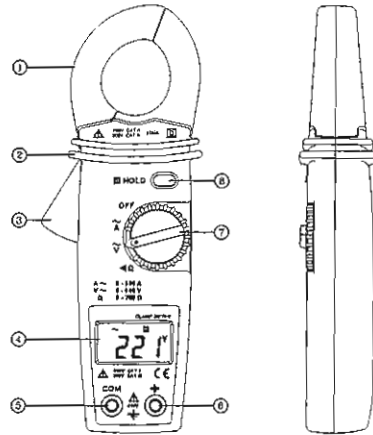

- | | |
|--------------------------|---------------------------|
| ① Current Sensing Clamp | ⑥ Positive input terminal |
| ② Safety protection ring | ⑦ Function select dial |
| ③ Clamp opening handle | ⑧ Data hold button |
| ④ LCD display | |
| ⑤ COM input terminal | |

IV. Measuring Instruction:

4.1 ACA measurement:

Switch the function selector to A~ range.

Open the clamp by pressing the jaw-opening handle and insert the cable to be measured into the jaw.

Close the clamp and get the reading from the LCD panel.

Note:

Before this measurement, disconnect the test lead with the meter for safety.

In some occasion that the reading is hard to read, push the HOLD button and read the result later.

CORRECT

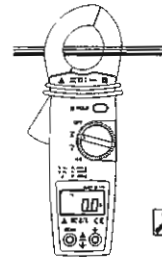
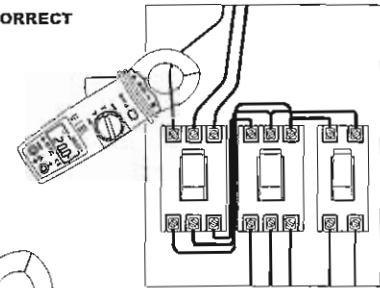

INCORRECT

4.2 ACV measurement:

Switch the function selector to V~ range.

Connect red test lead to "+" terminal and black one to the "COM" terminal.

Measure the voltage by touch the test lead tips to the test circuit where the value of voltage is needed.

Read the result from the LCD panel.

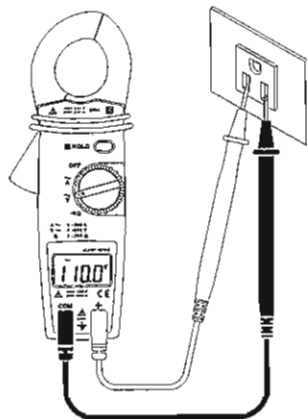

6

4.3 Resistance measurement:

Switch the function selector to Ω range.

Connect red test lead to "+" terminal and black one to the "COM" terminal.

Connect tip of the test leads to the points where the value of the resistance is needed.

Read the result from the LCD panel.

Note:

When take resistance value from a circuit system, make sure the power is cut off and all capacitors need to be discharged.

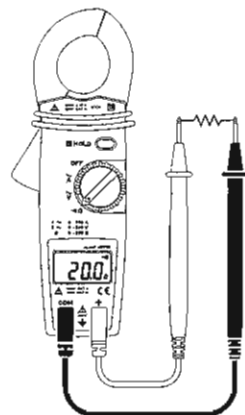

7

4.4 Continuity Test:

Switch the function selector to Ω (buzzer) range.

Connect red test lead to "+" terminal and black one to the "COM" terminal.

Connect tip of the test leads to the points where the conducting condition needed.

If the resistance is under 100Ω , the beeper will sound continuously.

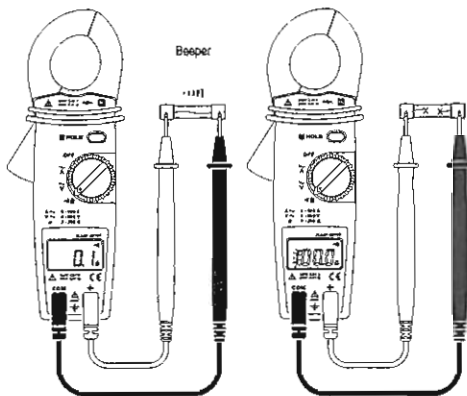

V. Battery Changing:

1. When the battery voltage drop below proper operation range the $\left[\begin{smallmatrix} \ominus \\ + \end{smallmatrix} \right]$ symbol will appear on the LCD display and the battery need to be changed.
2. Before changing the battery, switch the function selector to "OFF" and disconnect test leads.
 - Open the back cover by a screwdriver. Replace the old batteries with two UM-4 or AAA size batteries.
3. Close the back cover and fasten the screw.

VI. Maintenance:

CAUTION

To avoid contamination or static damage, do not touch the circuit board without proper static protection.

REMARK

- * If the meter is not going to be used for a long time, take out the battery and do not store the meter in high temperature or high humidity environment.
- * When make current measurement, keep the cable at the center of the clamp to get more accurate reading.

CLEANING

Periodically wipe the case with a dry cloth and without detergent. Do not use abrasives or solvents on this instrument.